

NOTICE

Note that when converting this document from its original format to a .pdf file, some minor font and format changes may occur. When viewing and printing this document, we cannot guarantee that your specific PC or printer will support all of the fonts or graphics. Therefore, when you view the document, fonts may be substituted and your individual printer may not have the capability to print the document correctly.

Smart Communication Server

SL1100

Single-Line Telephone

User Guide

**Please read this manual carefully before operating
this product and save this manual for future use.**

Before using Your Terminal...

Thank you for purchasing NEC SL1100 system.

Due to the flexibility built into the system, your **Dialing Codes and Feature Capacities** may differ from those in this guide. Check with your NEC Authorized Supplier / System Administrator and make a note of any differences.

NEC Single-Line Telephone (AT-45) is displayed here. This User Guide describes general analog Single-Line Telephone (SLT) procedures. Refer to the User Guide included with to your specific SLT for details on additional key functions.

Hookflash

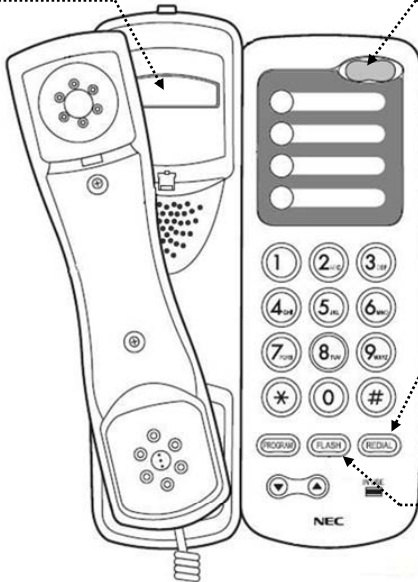

INDICATOR

Flashes when you have Message Waiting or there is an incoming call.

REDIAL Key

Press REDIAL Key to automatically redial the last number you dialed.

FLASH (RECALL) Key

While on a call, press FLASH Key to hold the line.

NEC Single-Line Telephone
(AT-45)

NEC Corporation reserves the right to change the specifications, functions, or features at any time without notice. NEC Corporation has prepared this document for use by its employees and customers. The information contained herein is the property of NEC Corporation and shall not be reproduced without prior written approval of NEC Corporation.

Copyright 2011, NEC Corporation

Printed in Japan

Placing Calls

■ Place an Outside Call <Quick Access>

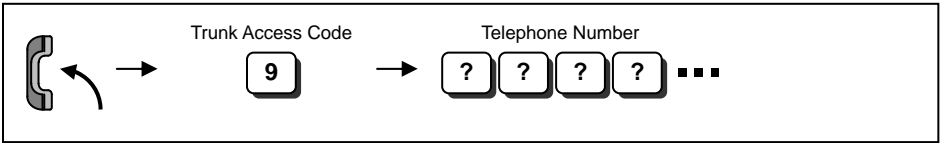

- To change the Trunk Access Code, ask your NEC Authorized Supplier for the details.
- Listen to the Dial Tone before dialing a Telephone Number.

■ Place an Intercom Call <Dial Access>



- Your call will ring or voice-announce. If you hear ringing, wait for an answer. If you hear a beep, begin speaking. Dialing "1" changes voice/ring mode (If the destination is Multi-line Terminal).

Placing Calls Quickly

■ Abbreviated (Speed) Dialing <for Outside>

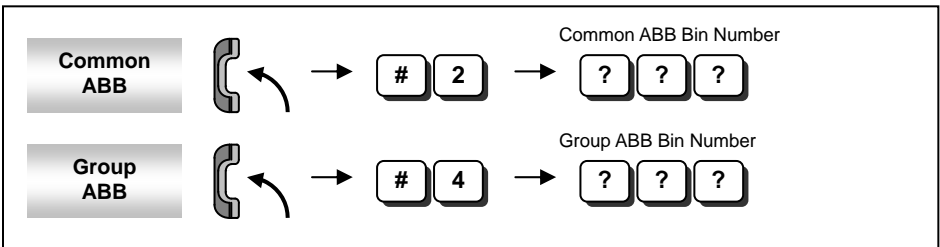

- The number of digits dialed for Bin No. depends on the system setting (0-9<Only Group ABB> / 00-99 / 000-999).
- Telephone Numbers are pre-registered to the system.
- System setting is necessary for Group ABB. Ask your NEC Authorized Supplier for the details.

■ Last Number Dialing <for Outside/Intercom>



If your call doesn't go through...

■ Set Camp On / Callback

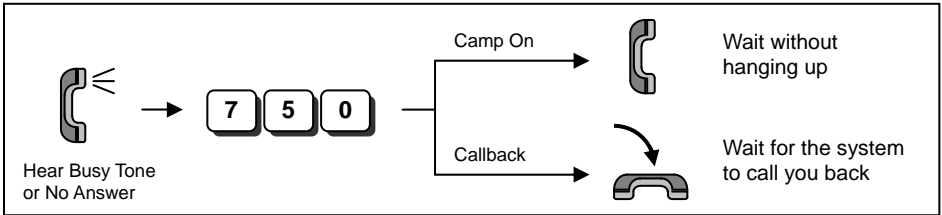

- **Camp On** *Intercom Call - you hear ringing, wait for the called party to answer.
Outside Call - you hear Dial Tone, begin telephone number dialing.*
- **Callback** *Intercom Call - your terminal starts the ringing, lift handset and wait for the called party to answer.
Outside Call - your terminal starts the ringing, lift handset, hear Dial Tone, and begin telephone number dialing.*
- *This function is applicable when all trunks are busy (not applicable for dialed outside party busy).*

■ Cancel Camp On / Callback

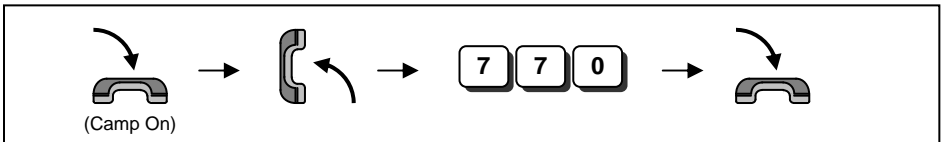

■ Set / Answer a Message Waiting

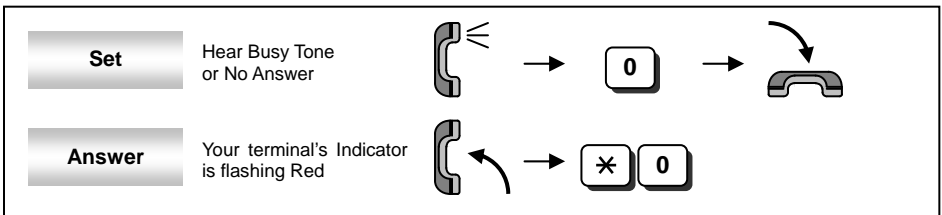

- *When you set a MW, the called party's Indicator starts to flash.*
- *When you answer a MW, the Indicator automatically goes off when the called party answers.*

■ Cancel Message Waiting

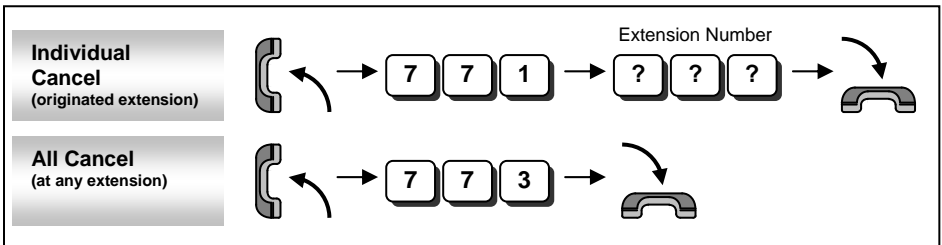

Answering Calls

■ Answering an Outside Call / Intercom Call (at Ringing Extension)



■ Picking Up a Call for other Extensions

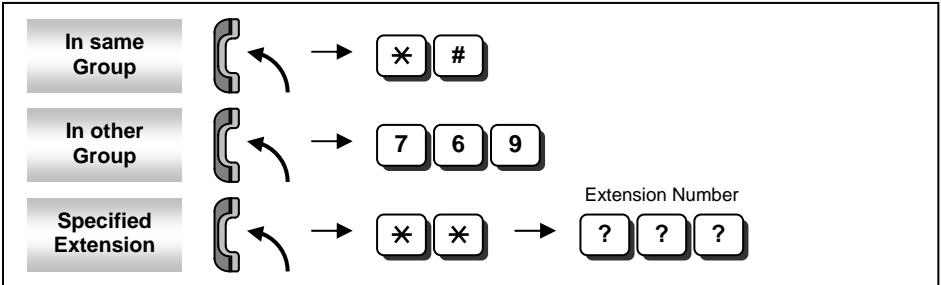

- System setting is necessary to create a Call Pickup Group. Ask your NEC Authorized Supplier for the details.

Hold / Transferring Calls

■ Holding a Call / Retrieving a Held Call

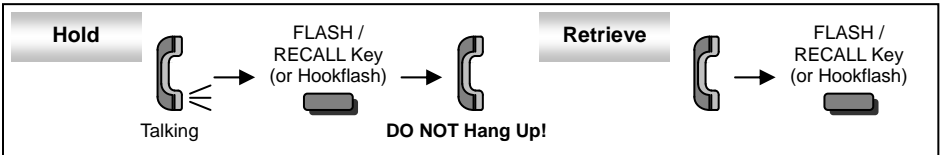

- If you go on hook, the held call will ring back.
- This operation puts your outside call on Exclusive Hold. Other extension users can not take the call off Hold.

■ Retrieve a Held Outside Call

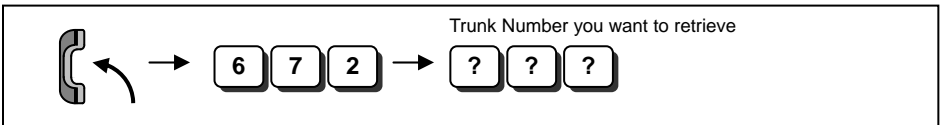

- Ask your NEC Authorized supplier for details about your Trunk Number dialing digits.

■ Transferring a Call to the other Extension

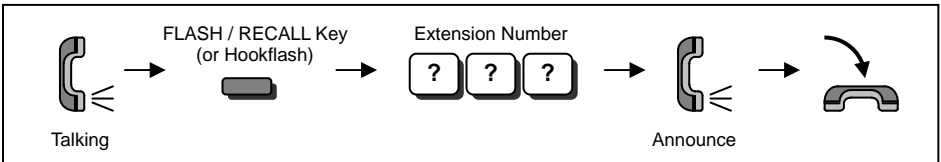

For more Convenient Use...

■ Do Not Disturb (DND)

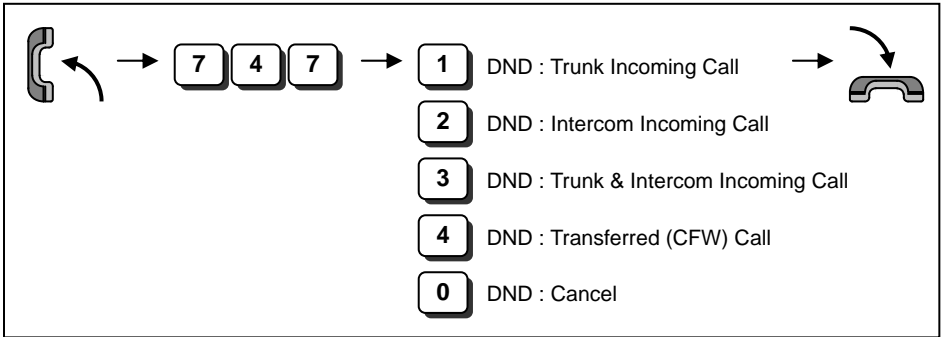

- When you set DND function, the Internal Dial Tone pattern is changed.

■ Conference

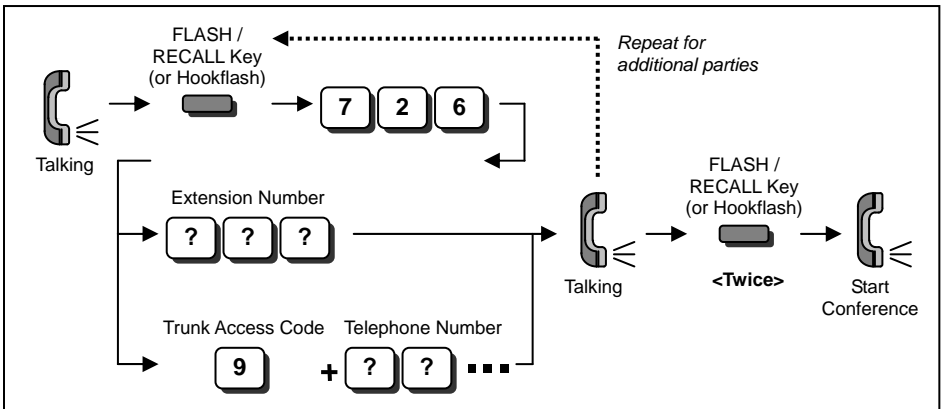

- You can repeat this operation to add more parties.
- You may be able to have up to 16 parties (including your extension). You may need to adjust the volume level due to the environment where calls are placed. Ask your NEC Authorized Supplier for details.

■ Call Forwarding / Follow Me

When you set Call Forward / Follow Me function, the Internal Dial Tone pattern will change.

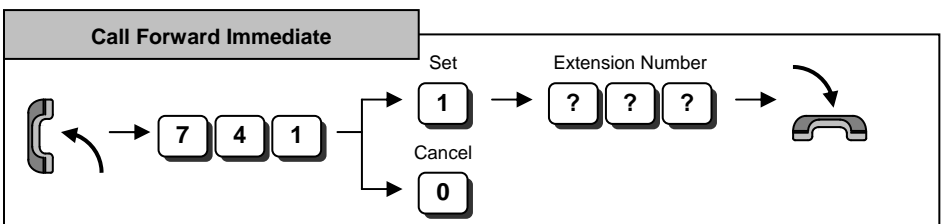

For more Convenient Use...

■ Call Forwarding / Follow Me (Cont'd)

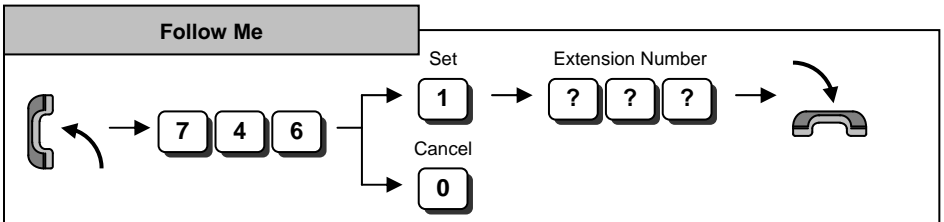
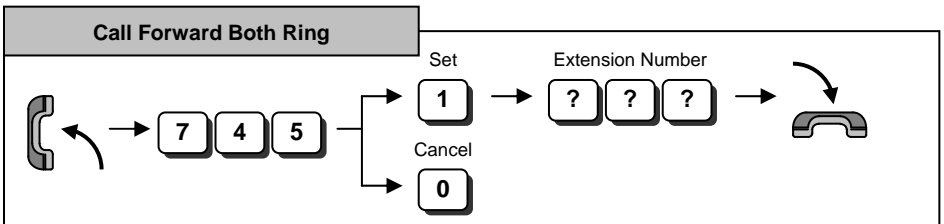
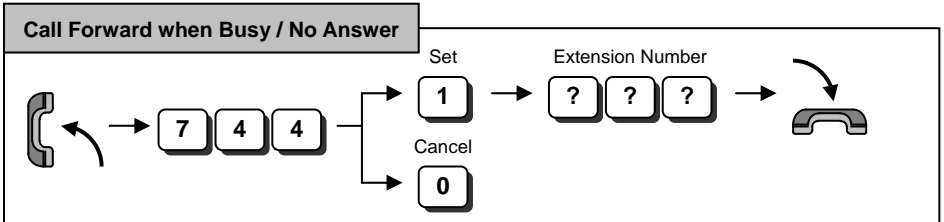
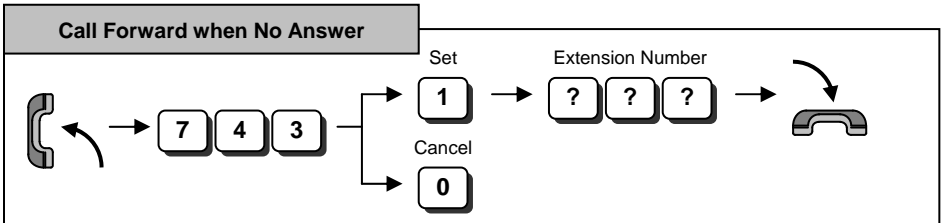
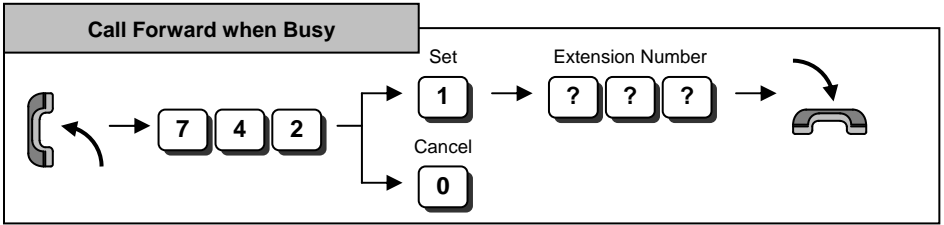

Built-In Answering Machine (VRS Message)

System setting is necessary to use a Built-In Answering Machine. Ask your NEC Authorized Supplier for details.

Record / Listen / Erase Answering Messages

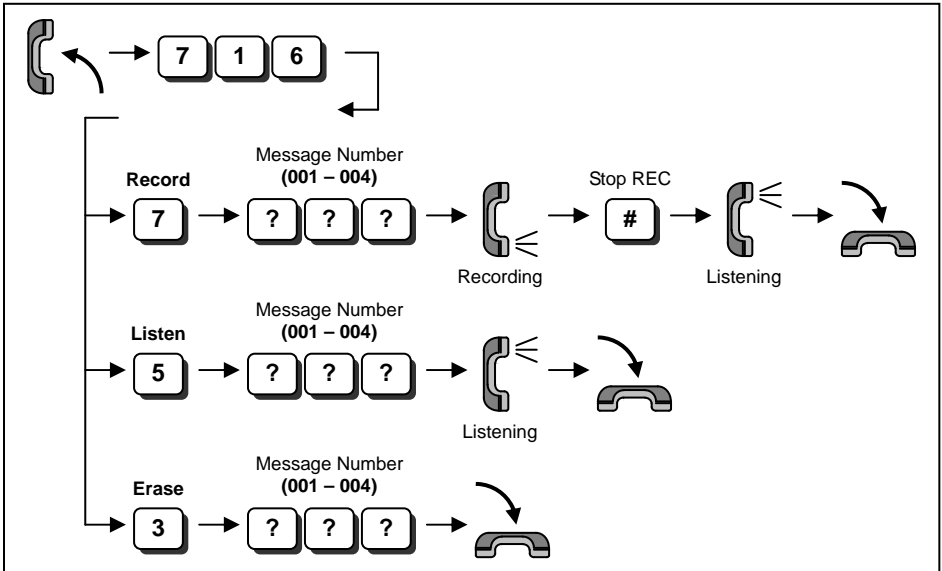

- Up to 4 types of messages can be recorded.
- The message length can not exceed 2 minutes.

Built-In Answering Machine (Voice Mail Message)

Listen / Erase Left Messages

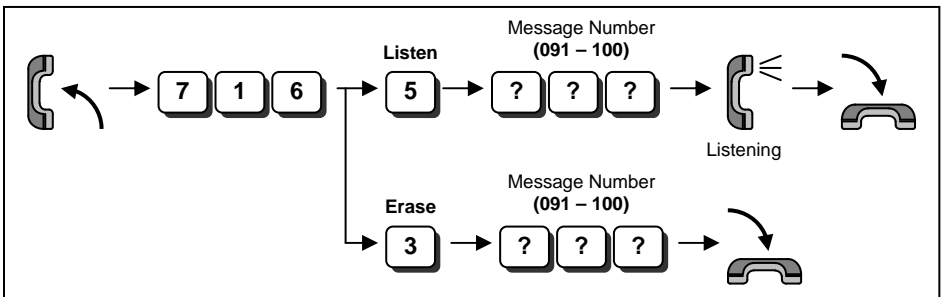

- A maximum of 10 messages can be left by outside callers.
- The message length can not exceed 2 minutes.

Option : In-Mail (Voice Mail)

Optional hardware and System setting is necessary to use In-Mail (Voice Mail) feature. Ask your NEC Authorized Supplier for the details.

■ Log-On to the In-Mail

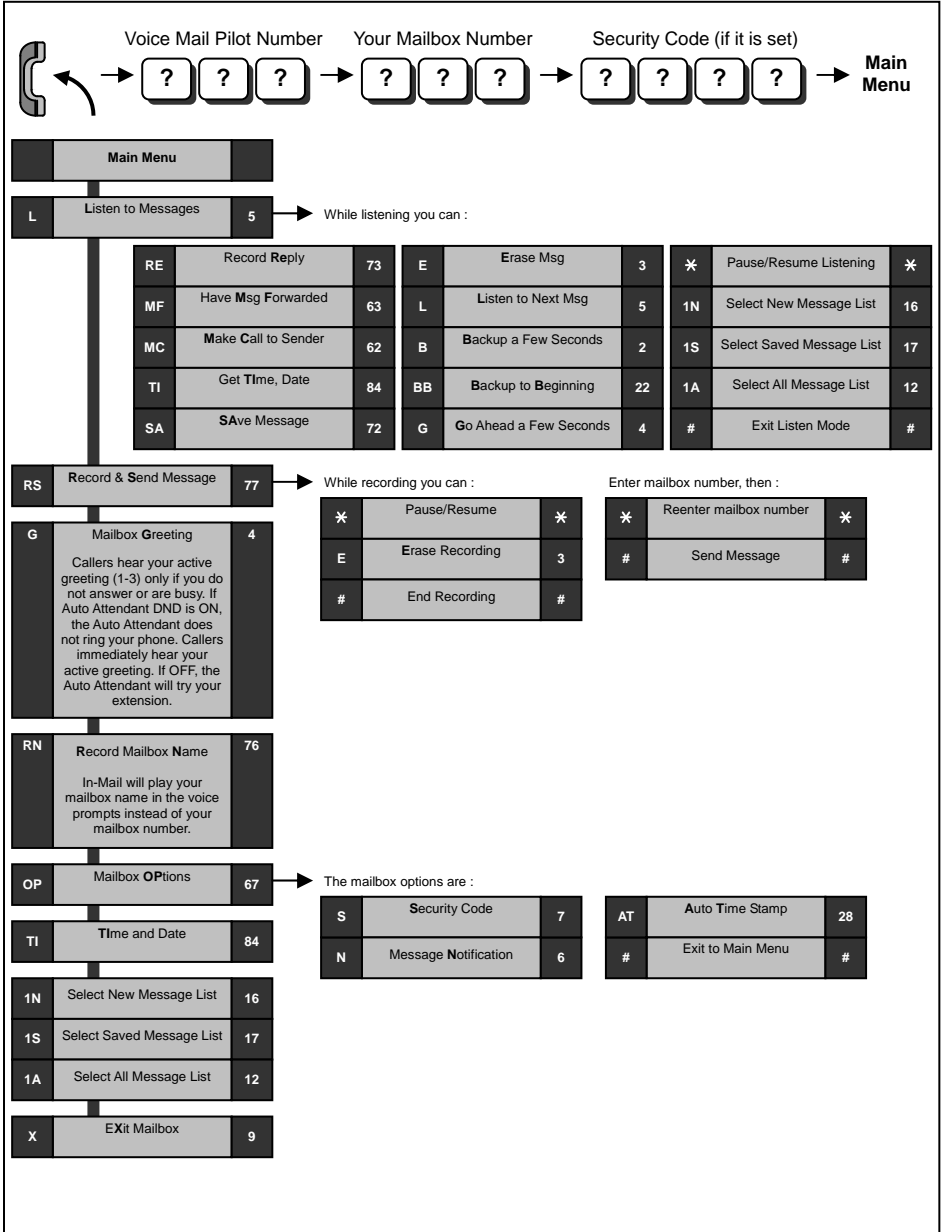

Option : In-Mail (Voice Mail)

■ Call Forward to Voice Mail

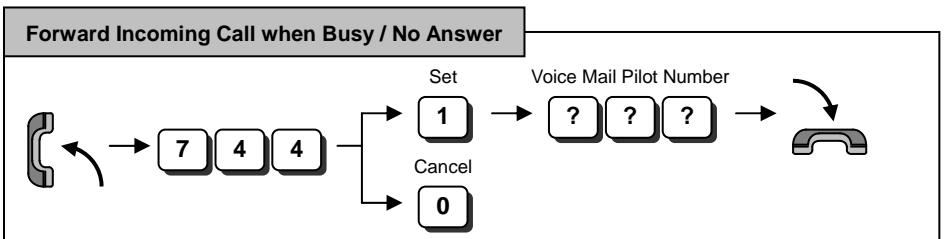
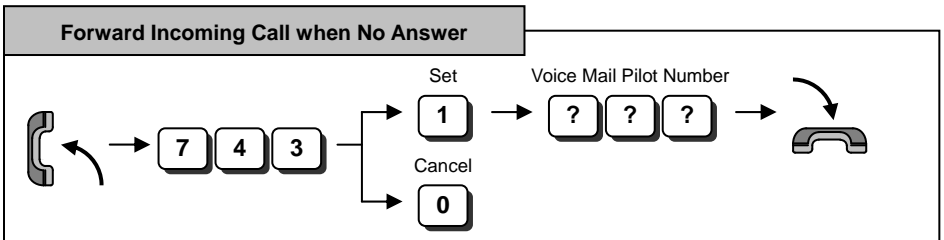
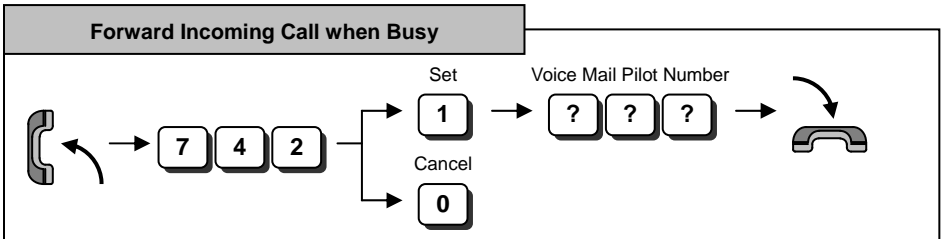
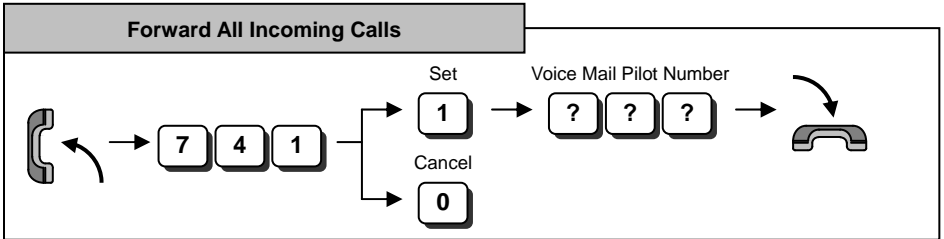

Option : In-Mail (Voice Mail)

■ Mailbox Greeting

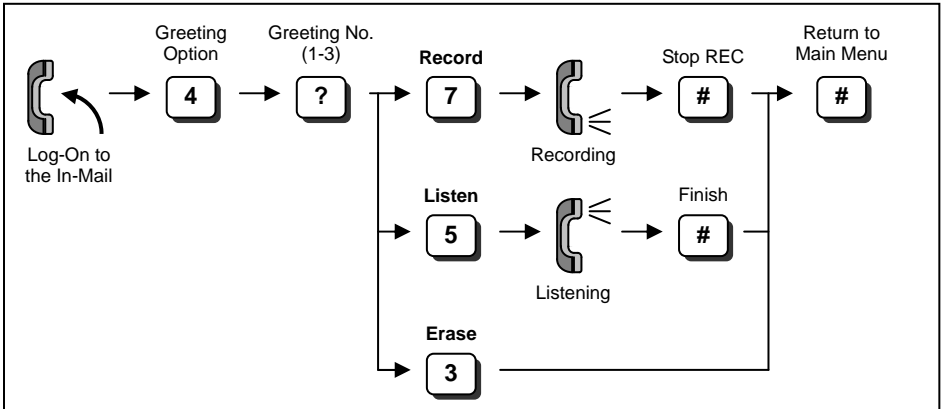

- Selected Greeting (one of three) becomes active.

■ Mailbox Security Code

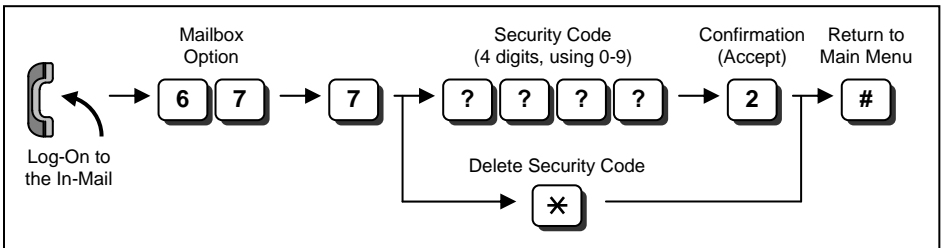

- Dialed Security Code can be canceled by pressing "4" instead of "2 (Accept)".
- In case the "In-Mail Advanced Features License (SL-VM-ADVANCE LIC)" is provided, or during Free Trial period (60 days after new installation), the type of Security Code can be assigned as below.
 - Dial 4 digits Security Code followed by "7": Security Code for all log-on
 - Dial 4 digits Security Code followed by "6": Security Code for remote log-on only
- System Administrator can delete a Mailbox Security Code.

■ Listen to Left Messages in your Mailbox

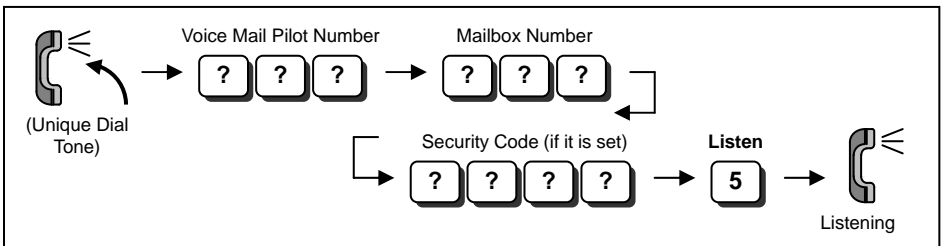

A50-031930-001
Issue 1.0
June 2011

SL1100

Single-Line Telephone
User Guide

NEC Corporation